

**PROPRIETARY AND CONFIDENTIAL**

THE INFORMATION CONTAINED IN THIS DRAWING IS THE SOLE PROPERTY OF DYTRAN INSTRUMENTS INC. ANY REPRODUCTION IN PART OR AS A WHOLE WITHOUT THE WRITTEN PERMISSION OF DYTRAN INSTRUMENTS, INC. IS PROHIBITED

**REVISIONS**

REV.	ECN	DESCRIPTION	BY/DATE	CHK	APPR
C	13192	NOTE 6: IS:...DYTRAN 6967AXX, WAS...DYTRAN 6811AXX	EM 12/21/16	LW	AS

MODEL	SENSITIVITY	OPERATING TEMPERATURE
3313A1	1 mV/g	-60° TO 250° F
3313A2	5 mV/g	-60° TO 250° F
3313A3	10 mV/g	-60° TO 250° F
3313A1H	1 mV/g	-60° TO 325° F
3313A2H	5 mV/g	-60° TO 325° F
3313A3H	10 mV/g	-60° TO 325° F
3313A4	5 mV/g	-320° TO 250° F

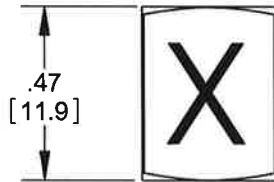
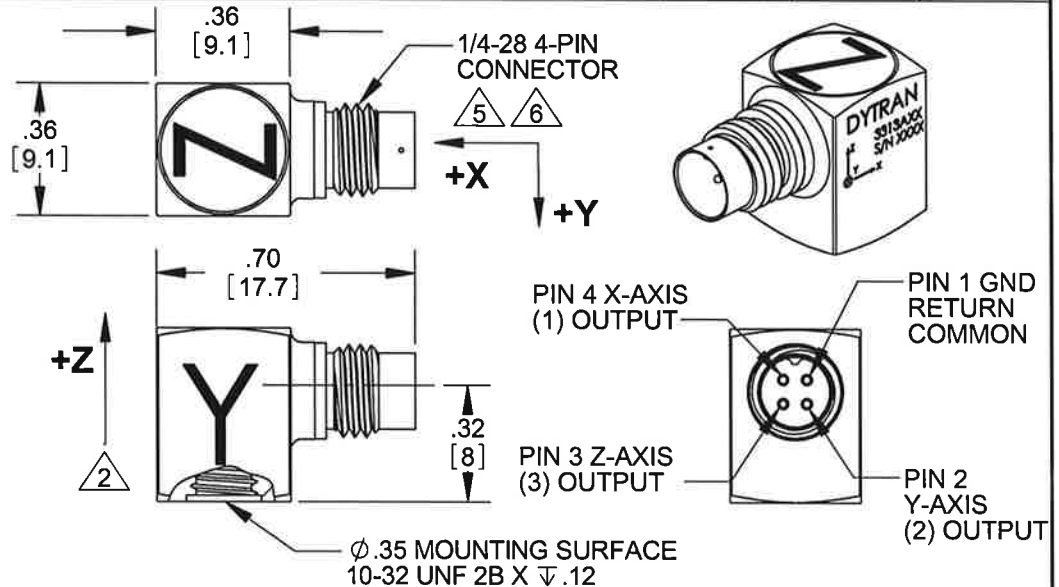

7 RECOMMENDED MOUNTING TORQUE 6-8 lb-in.

6 3313AXH MATES WITH DYTRAN 6967AXX CABLE (XX= LENGTH IN FEET)

5 3313AX MATES WITH DYTRAN 6811AXX OR 6824AXX CABLE (XX= LENGTH IN FEET)

- 4. SENSITIVITY: SEE CHART
- 3. WEIGHT: 4 GRAMS APPROX.

2 ARROWS INDICATE ACCELERATION

DIRECTION FOR POSITIVE OUTPUT

- 1. MATERIAL: TITANIUM ALLOY

NOTES: UNLESS OTHERWISE SPECIFIED

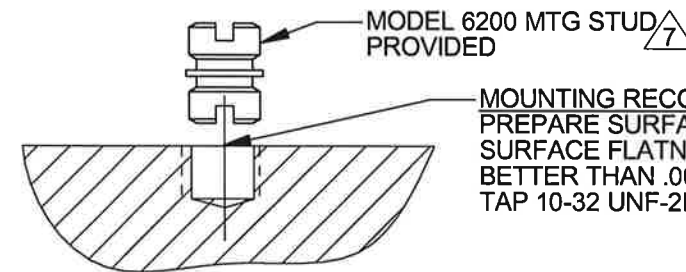

CONTRACT NO.



TITLE: <b>OUTLINE/INSTALLATION DRAWING, 3313A SERIES</b>			
SIZE <b>A</b>	CAGE CODE <b>2W033</b>	DWG. NO. <b>127-3313A</b>	REV <b>C</b>
SCALE: 2:1		SOLIDWORKS	SHEET 1 OF 1

APPROVALS		DATE
ORIG	JS	06/04/10
CHK	LW	1/3/17
APP		
APP		

UNLESS OTHERWISE SPECIFIED:  
 INTERPRET DIM & TOL PER ASME Y14.5M - 1994.  
 REMOVE BURRS.  
 COUNTERSINK INTERNAL THDS 90° TO MAJOR DIA.  
 CHAM EXT THDS 45° TO MINOR DIA.  
 THD LENGTHS AND DEPTHS ARE FOR MIN FULL THDS.  
 THDS PER MIL-S-7742.  
 DIMENSIONS APPLY AFTER FINISHING.  
 ALL MACHINED SURFACES. TOTAL RUNOUT WITHIN .005.  
 BREAK SHARP EDGES .005 TO .010.  
 MACHINED FILLET RADII .005 TO .015.  
 WELDING SYMBOLS PER AWS A2.4.  
 ABBREVIATIONS PER MIL-STD-12.

UNLESS OTHERWISE SPECIFIED:  
 DIMENSIONS ARE IN INCHES. DIMENSIONS IN BRACKETS [ ] ARE IN MILLIMETERS  
 TOLERANCES ARE:  
 INCHES METRIC ANGLES  
 .XX ± .03 X ± 0.8 ± 1°  
 .XXX ± 0.10 .XX ± 0.25

MATERIAL

FINISH

**DO NOT SCALE DRAWING**

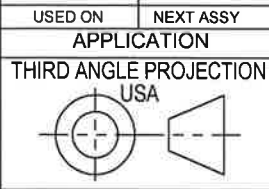



- **WEIGHT ONLY 4 GRAMS**
- **EXCELLENT LINEARITY**
- **TEMPERATURE STABILITY**
- **HERMETICALLY SEALED**

**PHYSICAL**

Weight, Max  
Connector  
Mounting Provision      Tapped Hole  
Material : Housing / Connector  
Element Style

ENGLISH		SI	
0.14	oz	4.1	grams
1/4-28, 4 - Pin		1/4-28, 4 - Pin	
10-32		10-32	
Titanium		Titanium	
Quartz Planar Shear		Quartz Planar Shear	

**PERFORMANCE**

Sensitivity, ±10% [1]  
Range F.S (each axis)  
Frequency Response, ± 15%  
Equivalent Natural Frequency  
Equivalent Electrical Noise, Max [7]  
Linearity [2]  
Maximum Transverse sensitivity  
Signal Polarity [3]

10	mV/g	1.02	mV/m/s <sup>2</sup>
±500	g	±4905	m/s <sup>2</sup>
1.2 to 10000	Hz	1.2 to 10000	Hz
> 30	kHz	> 30	kHz
0.007	grms	0.07	m/s <sup>2</sup> rms
± 1	% F.S.	± 1	% F.S.
5	%	5	%
Positive		Positive	

**ENVIRONMENTAL**

Maximum Vibration  
Maximum Shock  
Temperature Range  
Seal  
Base Strain

± 600	g's, peak	± 5886	m/s <sup>2</sup> peak
±5000	g's, peak	± 49050	m/s <sup>2</sup> peak
-60 to +250	°F	-51 to +121	°C
Hermetic		Hermetic	
0.006	g/μe	0.06	m/s <sup>2</sup> /μe

**Electrical**

Supply Current Range  
Compliance (Supply) Voltage Range  
Output Impedance, Typ  
Bias Voltage  
Discharge Time Constant  
Ground Isolation

2 to 20	mA	2 to 20	mA
+ 18 to +30	Volts	+ 18 to +30	Volts
100	Ω	100	Ω
+7 to +9	VDC	+7 to +9	VDC
0.2 to 1.0	Sec	0.2 to 1.0	Sec
Case Ground		Case Ground	

**This family also includes:**

Model	Sensitivity (mV/g)	Range F.S (g)	Time Constant (sec)	Operating Temperature (°F)
3313A1	1	± 5000	0.2 to 1.0	-60 to +250
3313A2	5	± 1000	0.2 to 1.0	-60 to +250

Please, refer to the performance specifications of the products in this family for detailed description

**Supplied Accessories:**

- 1) Accredited calibration certificate (ISO 17025)
- 2) Model 6200 mounting stud

**Notes:**

- [1] Measure at 100Hz, 1 grms per ISA RP 37.2
- [2] Measure using zero-based straight line method, % of F.S. or any lesser range.
- [3] For motion in direction of arrows on housing.
- [4] Do not apply power to this system without current limiting, 20 mA MAX. To do so will destroy the IC charge amplifier.
- [5] In the interest of constant product improvement, we reserve the right to change specifications without notice.
- [6] Mates with Dytran 6811AXX or 6824AXX cable (XX = Length in feet)
- [7] Typical. Not to exceed 0.010 Grms [0.10 m/s<sup>2</sup>]

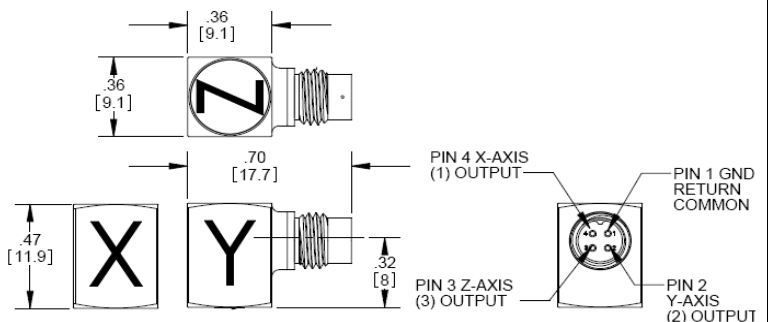
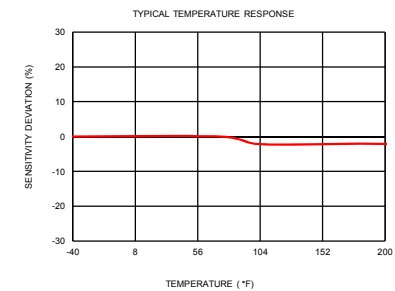
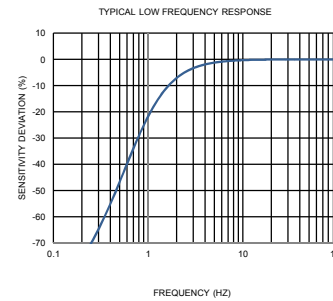

Units on the line drawing are in inches. Refer to 127-3313A for more information.

