

PROPRIETARY AND CONFIDENTIAL

THE INFORMATION CONTAINED IN THIS DRAWING IS THE SOLE PROPERTY OF DYTRAN INSTRUMENTS INC. ANY REPRODUCTION IN PART OR AS A WHOLE WITHOUT THE WRITTEN PERMISSION OF DYTRAN INSTRUMENTS, INC. IS PROHIBITED

REVISIONS

REV.	ECN	DESCRIPTION	BY/DATE	CHK	APPR
C	13192	NOTE 6: IS:...DYTRAN 6967AXX, WAS...DYTRAN 6811AXX	EM 12/21/16	LW	AS

MODEL	SENSITIVITY	OPERATING TEMPERATURE
3313A1	1 mV/g	-60° TO 250° F
3313A2	5 mV/g	-60° TO 250° F
3313A3	10 mV/g	-60° TO 250° F
3313A1H	1 mV/g	-60° TO 325° F
3313A2H	5 mV/g	-60° TO 325° F
3313A3H	10 mV/g	-60° TO 325° F
3313A4	5 mV/g	-320° TO 250° F

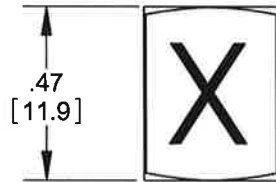
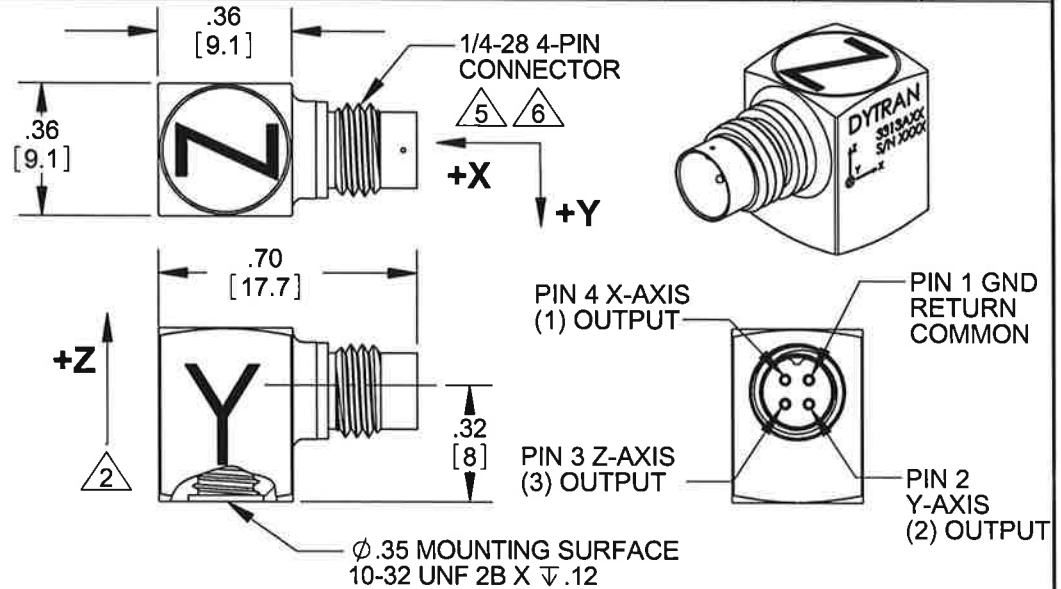

- 7 RECOMMENDED MOUNTING TORQUE 6-8 lb-in.
 - 6 3313AXH MATES WITH DYTRAN 6967AXX CABLE (XX= LENGTH IN FEET)
 - 5 3313AX MATES WITH DYTRAN 6811AXX OR 6824AXX CABLE (XX= LENGTH IN FEET)
 - 4. SENSITIVITY: SEE CHART
 - 3. WEIGHT: 4 GRAMS APPROX.
 - 2 ARROWS INDICATE ACCELERATION DIRECTION FOR POSITIVE OUTPUT
 - 1. MATERIAL: TITANIUM ALLOY
- NOTES: UNLESS OTHERWISE SPECIFIED

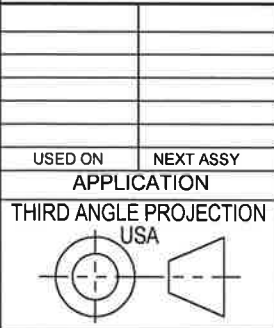
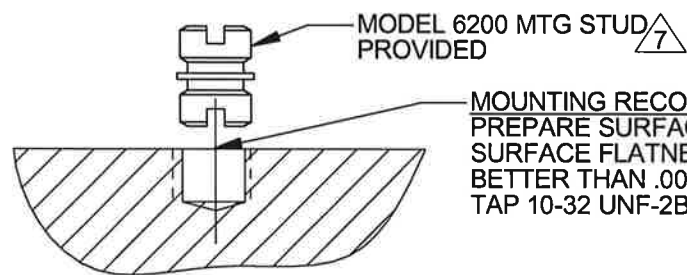

UNLESS OTHERWISE SPECIFIED:
 INTERPRET DIM & TOL PER ASME Y14.5M - 1994.
 REMOVE BURRS.
 COUNTERSINK INTERNAL THDS 90° TO MAJOR DIA.
 CHAM EXT THDS 45° TO MINOR DIA.
 THD LENGTHS AND DEPTHS ARE FOR MIN FULL THDS.
 THDS PER MIL-S-7742.
 DIMENSIONS APPLY AFTER FINISHING.
 ALL MACHINED SURFACES. TOTAL RUNOUT WITHIN .005.
 BREAK SHARP EDGES .005 TO .010.
 MACHINED FILLET RADII .005 TO .015.
 WELDING SYMBOLS PER AWS A2.4.
 ABBREVIATIONS PER MIL-STD-12.

UNLESS OTHERWISE SPECIFIED:
 DIMENSIONS ARE IN INCHES. DIMENSIONS IN BRACKETS [] ARE IN MILLIMETERS
 TOLERANCES ARE:
 INCHES METRIC ANGLES
 .XX ± .03 X ± 0.8 ± 1°
 .XXX ± 0.10 .XX ± 0.25

MATERIAL

FINISH

DO NOT SCALE DRAWING

CONTRACT NO.

APPROVALS		DATE
ORIG	JS	06/04/10
CHK	LW	1/3/17
APP		
APP		

MASTER COPY IF IN RED
 DYTRAN INSTRUMENTS, INC. Chatsworth, CA

TITLE: **OUTLINE/INSTALLATION DRAWING, 3313A SERIES**

SIZE	CAGE CODE	DWG. NO.	REV
A	2W033	127-3313A	C

SCALE: 2:1 SOLIDWORKS SHEET 1 OF 1



- **WEIGHT ONLY 4 GRAMS**
- **EXCELLENT LINEARITY**
- **HIGH TEMPERATURE**
- **HERMETICALLY SEALED**

PHYSICAL

Weight, Max
Connector
Mounting Provision
Material : Housing / Connector
Element Style

Tapped Hole

ENGLISH		SI	
0.14	oz	4.1	grams
1/4-28, 4 - Pin		1/4-28, 4 - Pin	
10-32		10-32	
Titanium		Titanium	
Quartz Planar Shear		Quartz Planar Shear	

PERFORMANCE

Sensitivity, ±10% [1]
Range F.S (each axis)
Frequency Response, ± 15%
Equivalent Natural Frequency
Equivalent Electrical Noise, Max
Linearity [2]
Maximum Transverse sensitivity
Signal Polarity [3]

5	mV/g	0.51	mV/m/s ²
±1000	g	±9810	m/s ²
1.2 to 10000	Hz	1.2 to 10000	Hz
> 30	kHz	> 30	kHz
0.009	grms	0.09	m/s ² rms
± 1	% F.S.	± 1	% F.S.
5	%	5	%
Positive		Positive	

ENVIRONMENTAL

Maximum Vibration
Maximum Shock
Temperature Range
Seal
Base Strain

± 2000	g's,peak	± 19620	m/s ² ,peak
±5000	g's,peak	± 49050	m/s ² ,peak
-60 to +325	°F	-51 to +162	°C
Hermetic		Hermetic	
0.006	g/μe	0.06	m/s ² /μe

Electrical

Supply Current Range
Compliance (Supply) Voltage Range
Output Impedence, Typ
Bias Voltage
Discharge Time Constant
Ground Isolation

2 to 20	mA	2 to 20	mA
+ 18 to +30	Volts	+ 18 to +30	Volts
100	Ω	100	Ω
+7 to +9	VDC	+7 to +9	VDC
0.2 to 1.0	Sec	0.2 to 1.0	Sec
Case Ground		Case Ground	

This family also includes:

Model	Sensitivity (mV/g)	Range F.S (g)	Time Constant (sec)	Operating Temperature (°F)
3313A1H	1	± 5000	0.2 to 1.0	-60 to +325
3313A3H	10	± 500	0.2 to 1.0	-60 to +325

Please, refer to the performance specifications of the products in this family for detailed description

Supplied Accessories:

- 1) Accredited calibration certificate (ISO 17025)
- 2) Model 6200 mounting stud

Notes:

- [1] Measure at 100Hz, 1 grms per ISA RP 37.2
- [2] Measure using zero-based straight line method, % of F.S. or any lesser range.
- [3] For motion in direction of arrows on housing.
- [4] Do not apply power to this system without current limiting, 20 mA MAX. To do so will destroy the IC charge amplifier.
- [5] In the interest of constant product improvement, we reserve the right to change specifications without notice.
- [6] Mates with Dytran 6967AXX (XX = Length in feet)

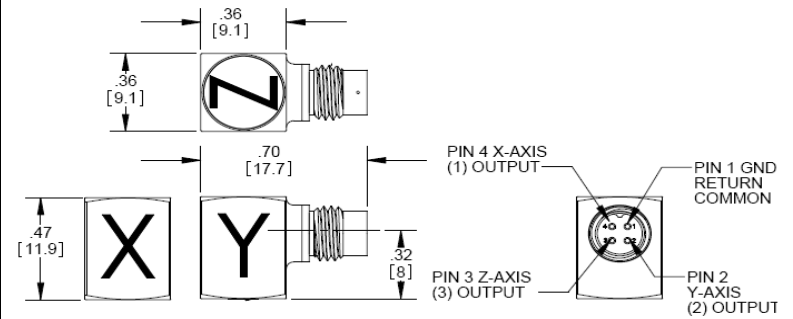
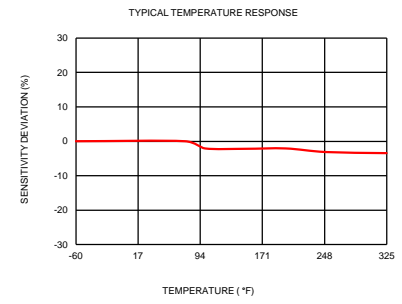
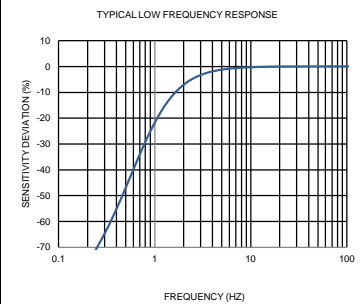

Units on the line drawing are in inches. Refer to 127-3313AH for more information.

