

PROPRIETARY AND CONFIDENTIAL

THE INFORMATION CONTAINED IN THIS DRAWING IS THE SOLE PROPERTY OF DYTRAN INSTRUMENTS INC. ANY REPRODUCTION IN PART OR AS A WHOLE WITHOUT THE WRITTEN PERMISSION OF DYTRAN INSTRUMENTS INC. IS PROHIBITED

7 CABLE TOLERANCES

ENGLISH		[METRIC]	
≥ 1 FT	+1/-0 IN	≥ 0.3 m	+25 mm -0 mm
>1 FT - 5 FT	+2/-0 IN	> 0.3 m- 1.5 m	+50 mm -0 mm
>5 FT - 10 FT	+4/-0 IN	>1.5 m -3 m	+100 mm -0 mm
>10 FT - 25 FT	+6/-0 IN	> 3 m -7.5 m	+150 mm -0 mm
>25 FT	+5%/-0%	> 7.5 m	+5%/-0%

7 4-WIRE CABLE

WIRE	36 AWG, 7/44 SILVER PLATED COPPER
WIRE INSULATION	PFA, .006 NOMINAL WALL
SHIELD	44 AWG DILVER PLATED SOFT COPPER BRAID
JACKET	PFA, WHITE, .006 INCH NOMINAL WALL
DIAMETER	Ø.045 NOMINAL
TEMP	-196°C TO +200° C
VOLTAGE	150 VOLTS AC

REV	ECN	DESCRIPTION	BY/DATE	CHK	APPR
H	12409	UPDATED VIEW OF CONNECTOR (KNURLING)	JS 12/15/15	LA	LN
J	12992	3133A5 SENSITIVITY WAS: 0.25 Mv/g (+/-25%)	JS 10/07/16	LA	LN
K	13061	REVISED "DYTRAN" TO REFLECT MARKING, AS SHIPPED	JS 10/07/16	RA	LN
L	13832	SEE ECN	RA 11/13/17	Sp	LN

VARIATION CHART

MODEL	SENSITIVITY	LENGTH ⁷
3133A1	10 mV/g (±15%)	36 IN
3133A2	2 mV/g (±25%)	36 IN
3133A3	5 mV/g (±20%)	36 IN
3133A4	0.7 mV/g (±25%)	36 IN
3133A5	0.2 mV/g (±25%)	36 IN
3133A1-05	10 mV/g (±15%)	5 FT
3133A2-05	2 mV/g (±25%)	5 FT
3133A3-05	5 mV/g (±20%)	5 FT

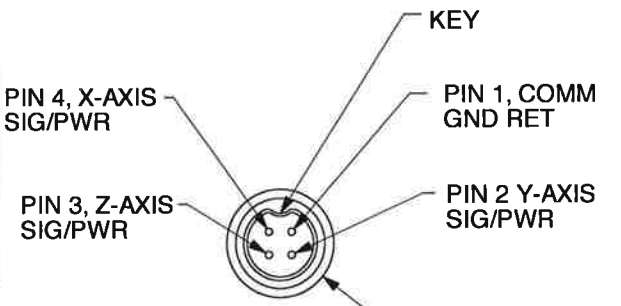
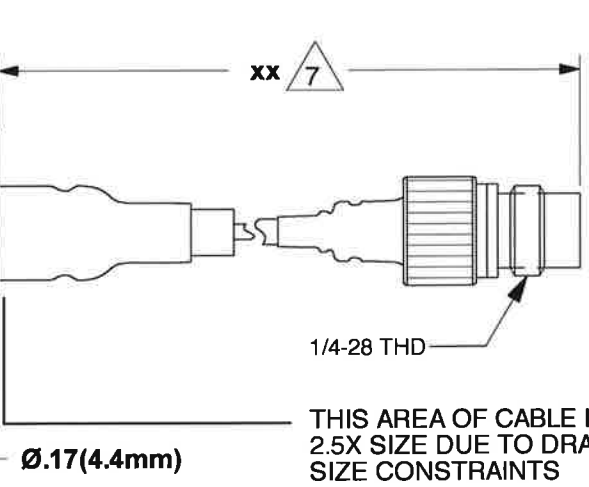
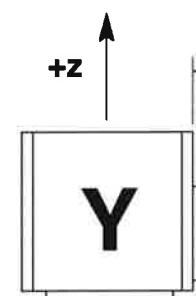
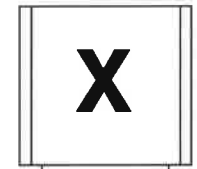
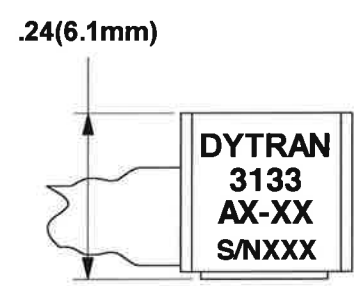
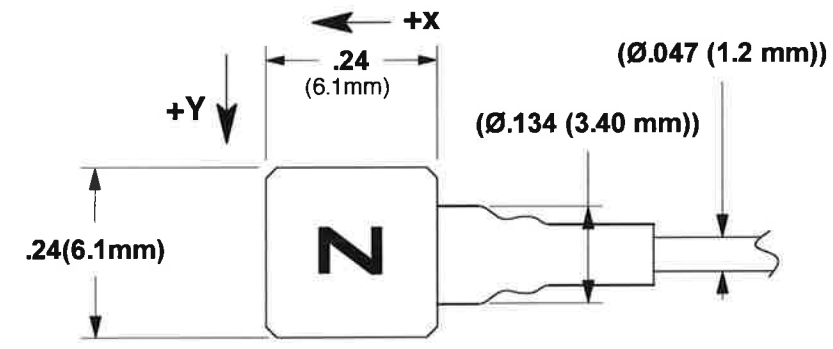

⁷ LENGTH OF CABLE ASSEMBLY IS DESIGNATED BY XX IN NUMBER (3133AX-XX). XX EQUALS CABLE LENGTH (SEE CHART) (I.E. 3133A1-05 IS A 5 FT LENGTH CABLE ASSEMBLY)

6. MODEL 6298 PETRO MOUNTING WAX IS INCLUDED.

⁵ MATING CABLES ARE MODELS 6824AXX (SANTOPRENE), OR 6811AXX, (TEFLON) 4-PIN CONNECTOR TO 3 BNC'S. "XX" IS THE CABLE LENGTH IN FEET. EX. :CABLE MOD. 6811A3 (3 FT. NOM.).

4. HOUSING MATERIAL: TITANIUM.

3. THE LETTERS "X", "Y", & "Z" INDICATE THE DIRECTION OF ACCELERATION OF EACH AXIS FOR POSITIVE GOING OUTPUT VOLTAGE (AS THE MARKED SURFACE ACCELERATES TOWARD THE VIEWER.) SEE DIRECTIONAL ARROWS ON FACE OF DRAWING.

² FOR BEST FREQUENCY RESPONSE, PREPARE FLAT MOUNTING SURFACE OF AT LEAST .20 DIAMETER, FLAT TO .0001 TIR. APPLY ONE DROP OF CYANOACRYLATE ADHESIVE TO MOUNT THE ACCELEROMETER.

1. WEIGHT, LESS CABLE: 0.8 GRAMS.

NOTES: UNLESS OTHERWISE SPECIFIED

UNLESS OTHERWISE SPECIFIED: INTERPRET DIM & TOL PER ASME Y14.5M - 1994. REMOVE BURRS. COUNTERSINK INTERNAL THDS 90° TO MAJOR DIA. CHAM EXT THDS 45° TO MINOR DIA. THD LENGTHS AND DEPTHS ARE FOR MIN FULL THDS. DIMENSIONS APPLY AFTER FINISHING.

ALL MACHINED SURFACES. TOTAL RUNOUT WITHIN .005. BREAK SHARP EDGES .005 TO .010. MACHINED FILLET RADII .005 TO .015. WELDING SYMBOLS PER AWS A2.4. ABBREVIATIONS PER MIL-STD-12.

APPROVALS		DATE
DRAWN	N.C.	11-10-08
DESIGN	N.C.	11-10-08
CHK	D.V.	05-18-09
APP	ANS	05-26-09

DO NOT SCALE DRAWING

DYTRAN INSTRUMENTS, INC. MASTER ONLY IF IN RED

Chattsworth, CA

TITLE: OUTLINE/INSTALLATION DRAWING, MODEL SERIES 3133A TRIAXIAL ACCELEROMETERS

SIZE	CAGE CODE	DWG NO	REV
B	2W033	127-3133A	L

SCALE: NONE ASHLAR GRAPHITE SHEET 1 OF 1

Model Number	PERFORMANCE SPECIFICATION	DOC NO PS3133A3
---------------------	----------------------------------	----------------------------------

3133A3	Accelerometer, Triaxial, IEPE	REV R, ECN 14713, 11/21/18
---------------	--------------------------------------	----------------------------

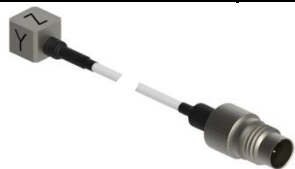

- **ULTRA MINIATURE SIZE**
- **IDEAL LOW FREQUENCY RESPONSE**

	ENGLISH	SI
PHYSICAL		
Weight	oz	grams
Size	inch	mm
Height	inch	mm
Mounting	Adhesive	Adhesive
Integral Cable	Length ft	mm
Connector Type	TFE	TFE
Housing	Material Titanium	Titanium
Sensing Element	Material Case Ground	Case Ground
	Material Ceramic	Ceramic
	Mode Shear	Shear

PHYSICAL

Weight
Size
Height
Mounting
Integral Cable
Connector Type
Housing
Sensing Element

PERFORMANCE

Sensitivity [1], [2], ± 20%
Acceleration Range
Frequency Range Axis, ±5%
Frequency Range Axis, ±10%
Linearity [4]
Resonance Frequency
Transverse Sensitivity
Bias Voltage
Output Impedance
Noise floor
Discharge Time Constant
Spectral Noise

Sensitivity [1], [2], ± 20%	mV/g	5	mV/m/s ²	0.5
Acceleration Range	Gpeak	1000	m/s ² peak	9810
Frequency Range Axis, ±5%	Hz	0.3 to 6000	Hz	0.3 to 6000
Frequency Range Axis, ±10%	Hz	0.25 to 10000	Hz	0.25 to 10000
Linearity [4]	% F.S.	± 1	% F.S.	± 1
Resonance Frequency	kHz	>35	kHz	>35
Transverse Sensitivity	%	6	%	6
Bias Voltage	VDC	+8 to +10	VDC	+8 to +10
Output Impedance	Ω	100	Ω	100
Noise floor	Grms	0.06	m/s ² rms	0.59
Discharge Time Constant	seconds	1.0 to 2.5	seconds	1.0 to 2.5
Spectral Noise	1Hz μGrms/sqr(Hz)	4000	μm/s ² rms/sqr(Hz)	39240
	10Hz μGrms/sqr(Hz)	2000	μm/s ² rms/sqr(Hz)	19620
	100Hz μGrms/sqr(Hz)	500	μm/s ² rms/sqr(Hz)	4905
	1000Hz μGrms/sqr(Hz)	200	μm/s ² rms/sqr(Hz)	1962
	10000Hz μGrms/sqr(Hz)	90	μm/s ² rms/sqr(Hz)	883

ENVIRONMENTAL

Shock
Vibration
Operating Temperature
Seal
Magnetic Sensitivity at 100 Gauss
Base Strain Sensitivity

Shock	Gpeak	3000	m/s ²	29430
Vibration	Gpeak	900	m/s ²	8829
Operating Temperature	°F	-67 to +320	°C	-55 to +160
Seal		Epoxy		
Magnetic Sensitivity at 100 Gauss	g/Gauss	0.00004	m/s ² /Gauss	0.00039
Base Strain Sensitivity	g/με	0.15	m/s ² /με	1.47

POWER

Compliance Voltage
Current Range

Compliance Voltage	VDC	+18 to +30	VDC	+18 to +30
Current Range	mA	2 to 20	mA	2 to 20

This family also includes:

Model	Sensitivity (mV/g)	Range (Gpeak)	Resolution (Grms)	Oper. Temp(°F)	TC
3133A1	10	500	0.02	-67 to 320	1.0 to 2.5
3133A2	2	2500	0.15	-67 to 320	0.3 to 2.5
3133A4	1	5000	0.15	-67 to 320	0.5 to 2.5
3133A5	0.2	20000	0.35	-67 to 320	0.5 to 4.0

Please, refer to the performance specifications of the products in this family for detailed description

Supplied Accessories:

- 1) Model 6298 small petro wax
- 2) Model 6741 removal tool
- 3) Accredited calibration certificate (ISO 17025)

Notes:

- [1] Measured at 100 Hz, 10 Grms
- [2] Actual sensitivity is given on a calibration certificate
- [3] Do not apply power to this device without current limiting, 20mA max, to do so will destroy the integral IC amplifier
- [4] Measured using zero-based straight line method, % of F.S. or any lesser range.

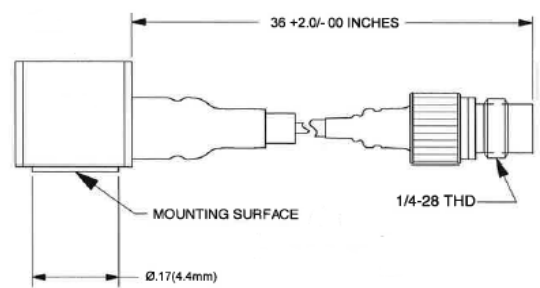
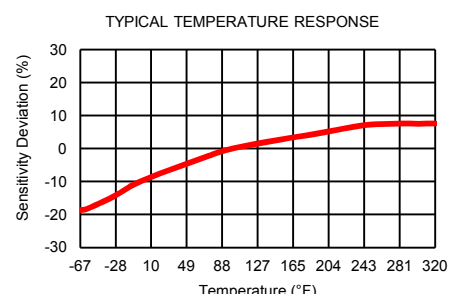
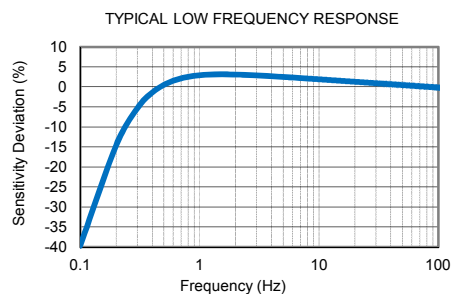

Units on the line drawing are in inches, units in brackets are in millimeters. Refer to 127-3133A for more information

