

**PROPRIETARY AND CONFIDENTIAL**

THE INFORMATION CONTAINED IN THIS DRAWING IS THE SOLE PROPERTY OF DYTRAN INSTRUMENTS INC. ANY REPRODUCTION IN PART OR AS A WHOLE WITHOUT THE WRITTEN PERMISSION OF DYTRAN INSTRUMENTS INC. IS PROHIBITED

**REVISIONS**

REV	ECN	DESCRIPTION	BY/DATE	CHK	APPR
A	11363	INITIAL RELEASE	JS 04/11/15	<i>[Signature]</i>	<i>[Signature]</i>

**VARIATION TABLE**

MODEL NO.	SENSITIVITY	TEDS
3023B7	1 mV/g	NO
3023B8	5 mV/g	NO
3023B9	10 mV/g	NO
3023B7T	1 mV/g	YES
3023B8T	5 mV/g	YES
3023B9T	10 mV/g	YES

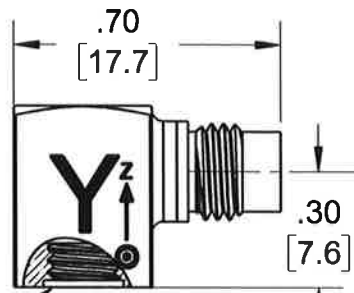
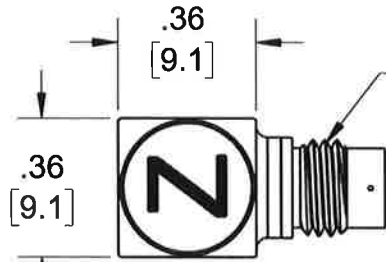
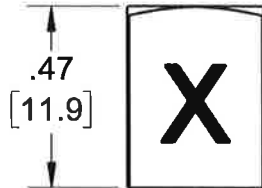
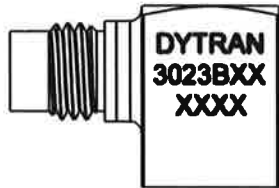

1/4-28 4-PIN CONNECTOR

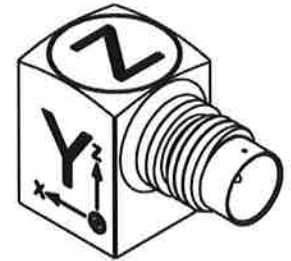

PIN 4  
X AXIS  
(1) OUTPUT

KEY

PIN 1  
GND

PIN 3  
Z AXIS  
(3) OUTPUT

PIN 2  
Y AXIS  
(2) OUTPUT

10-32 UNF-2B  $\nabla$  .12  
[ ] .14  $\nabla$  .02



7 MODEL 6200, 10-32 UNF-2A MOUNTING STUD, SUPPLIED

6 MATES WITH DYTRAN 6811AXX OR 6824AXX CABLE (XX=LENGTH IN FEET)

5. OPERATIONAL TEMPERATURE: RANGE -60° TO +325°F
4. SENSITIVITY: SEE CHART.
3. WEIGHT: 4 GRAMS MAX.
2. ARROWS INDICATE ACCELERATION DIRECTION FOR POSITIVE OUTPUT
1. MATERIAL: TITANIUM ALLOY

**MOUNTING RECOMMENDATIONS:**  
PREPARE SURFACE AT LEAST  $\phi$ .39 [7.5] FLAT TO .001 TIR.  
TAP 10-32 UNF-2B  $\nabla$  .140 [3.6] MIN.  
MOUNTING TORQUE: 10-12 Lb-in.

NOTES: UNLESS OTHERWISE SPECIFIED.

3023B7	
3023B8	
3023B9	
3023B7T	
3023B8T	
3023B9T	

UNLESS OTHERWISE SPECIFIED:  
INTERPRET DIM & TOL PER ASME Y14.5M - 1994.  
REMOVE BURRS.  
COUNTERSINK INTERNAL THDS 90° TO MAJOR DIA.  
CHAM EXT THDS 45° TO MINOR DIA.  
THD LENGTHS AND DEPTHS ARE FOR MIN FULL THDS.  
THDS PER MIL-S-7742.  
DIMENSIONS APPLY AFTER FINISHING.

UNLESS OTHERWISE SPECIFIED:  
DIMENSIONS ARE IN INCHES. DIMENSIONS IN BRACKETS [ ] ARE IN MILLIMETERS  
TOLERANCES ARE:  
INCHES METRIC ANGLES  
XX ± .03 X ± 0.8 ± 1°  
.XXX ± .010 .XX ± 0.25

USED ON NEXT ASSY

APPLICATION

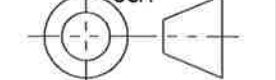

ALL MACHINED SURFACES  $\checkmark$  63/ TOTAL RUNOUT WITHIN .005. BREAK SHARP EDGES .005 TO .010. MACHINED FILLET RADII .005 TO .015. WELDING SYMBOLS PER AWS A2.4. ABBREVIATIONS PER MIL-STD-12.

MATERIAL  
FINISH  
DO NOT SCALE DRAWING

CONTRACT NO.



TITLE:  
**OUTLINE/INSTALLATION DRAWING, MODEL 3023B SERIES**

APPROVALS		DATE
ORIG	NDC	3/11/14
CHK	<i>[Signature]</i>	5-2-14
APP	<i>[Signature]</i>	5/9/15
APP		

SIZE	CAGE CODE	DWG. NO.	REV
<b>A</b>	<b>2W033</b>	<b>127-3023B7</b>	<b>A</b>

SCALE: NONE      SOLIDWORKS      SHEET 1 OF 1

<b>MODEL NUMBER</b> <b>3023B8T</b>	<b>PERFORMANCE SPECIFICATION</b>	<b>DOC NO.</b> <b>PS3023B8T</b>
	<b>ACCELEROMETER, TRIAXIAL, IEPE</b>	REV B, ECN 13594, 8/10/17



- **HIGH TEMPERATURE**
- **HERMETICALLY SEALED**
- **MINIATURE SIZE**
- **TEDS FEATURE**

**PHYSICAL**

Weight, Max.  
Mounting  
Connector [1]  
Material, Housing / Connector

ENGLISH			SI	
0.14	oz		4.0	grams
10-32 Tapped Hole			10-32 Tapped Hole	
4-pin			4-pin	
Titanium			Titanium	

**PERFORMANCE**

Sensitivity, -10% / +15% [2]  
Range F.S. (each axis)  
Frequency Response, ±5%  
, ±15%  
Element Natural Frequency  
Equivalent Electrical Noise  
Spectral Noise  
Linearity [3]  
Transverse Sensitivity, Max.  
Signal Polarity

	ENGLISH		SI	
Sensitivity	5	mV/g	0.51	mV/m/s <sup>2</sup>
Range	±1000	g	±9810	m/s <sup>2</sup>
Frequency Response	2.5 to 4000	Hz	2.5 to 4000	Hz
	2 to 10000	Hz	2 to 10000	Hz
Element Natural Frequency	25	kHz	25	kHz
	0.014	grms	0.1373	m/s <sup>2</sup> rms
Spectral Noise	1.25Hz	1360	μGrms/v(Hz)	13342
	10Hz	1360	μGrms/v(Hz)	13342
	100Hz	240	μGrms/v(Hz)	2354
	1000Hz	63	μGrms/v(Hz)	618
	10000Hz	44	μGrms/v(Hz)	432
Linearity	±1	% F.S.	±1	% F.S.
	5	%	5	%
Signal Polarity	[5]		[5]	

**ELECTRICAL**

Supply Current Range [4]  
Compliance Voltage Range  
Output Impedance, Typ.  
Output Bias Voltage  
Discharge Time Constant  
Magnetic Sens. at 100 Gauss  
Strain Sensitivity @ 250με  
Ground Isolation

	ENGLISH		SI	
Supply Current Range	2 to 20	mA	2 to 20	mA
Compliance Voltage Range	+18 to +30	VDC	+18 to +30	VDC
Output Impedance, Typ.	100	Ω	100	Ω
Output Bias Voltage	7 to 12	VDC	7 to 12	VDC
Discharge Time Constant	0.2 - 2.0	sec	0.2 - 2.0	sec
Magnetic Sens. at 100 Gauss	0.00005	g/Gauss	4.905	m/s <sup>2</sup> /T
Strain Sensitivity @ 250με	0.008	g/με	0.08	m/s <sup>2</sup> /με
Ground Isolation	Case Ground		Case Ground	

**ENVIRONMENTAL**

Maximum Shock  
Maximum Vibration  
Temperature Range  
TEDS Operating Temp.  
Environmental Seal  
TEDS

	ENGLISH		SI	
Maximum Shock	±2000	g pk	±19620	m/s <sup>2</sup>
Maximum Vibration	±1200	g pk	±11772	m/s <sup>2</sup>
Temperature Range	-60 to +325	°F	-51 to +162	°C
TEDS Operating Temp.	-40 to +185	°F	-40 to +85	°C
Environmental Seal	Hermetic		Hermetic	
TEDS	IEEE 1451.4		IEEE 1451.4	

**This family also includes:**

Model	Sensitivity (mV/g)	Range (Gpeak)	Resolution (Grms)	Oper. Temp (°F)	TC
3023B7	1	5000	0.07	-60 to +325	0.2 to 2.0
3023B8	5	1000	0.014	-60 to +325	0.2 to 2.0
3023B9	10	500	0.007	-60 to +325	0.2 to 2.0
3023B7T	1	5000	0.07	-60 to +325	0.2 to 2.0
3023B9T	10	500	0.007	-60 to +325	0.2 to 2.0

Please, refer to the performance specifications of the products in this family for detailed description

**Supplied Accessories:**

- 1) Accredited Calibration Certificate (ISO 17025)
- 2) Model 6200 Mounting Stud, Qty 1.

**Notes:**

- [1] Connector mates with Dytran's cable assy. model 6811AXX or 6824AXX. (xx = length in feet)
- [2] Measured At 100 Hz, 1 Grms per ISA RP 37.2
- [3] Measured using zero-based best straight-line method, % of F.S. or any lesser range.
- [4] Power only with Dytran IEPE power unit or other Dytran-compatible constant current type power unit. If power is applied without current limiting protection, the internal amplifier will be destroyed.
- [5] Positive for motion in direction of arrows on housing.
- [6] In the interest of constant product improvement, we reserve the right to change the specification without notice.

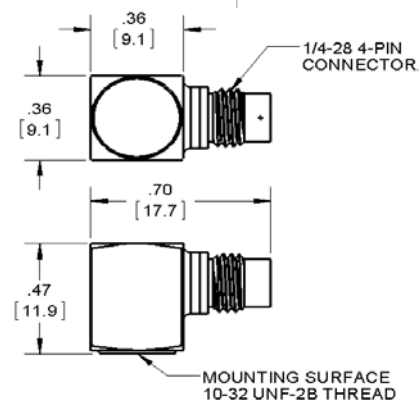
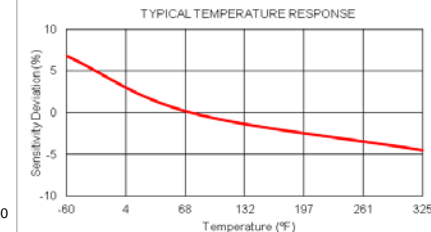
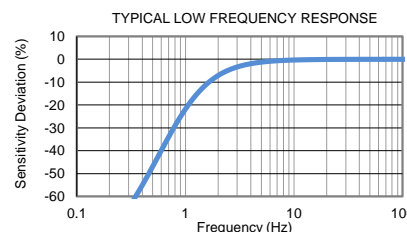

Units on the line drawing are in inches, units in brackets are in millimeters. Refer to 127-3023B7 for more information.



21592 Marilla Street, Chatsworth, California 91311 Phone: 818.700.7818 Fax: 818.700.7880  
www.dytran.com For permission to reprint this content, please contact info@dytran.com